

# Vehicle Information

Make and model **Toyota Corolla**

Engine size 1.8L Petrol

## How to unlock the vehicle

► Vehicles with a smart key system

① Locks all the doors

Check that the door is securely locked.

② Unlocks all the doors

Pressing the button unlocks the driver's door. Pressing the button again within 5 seconds unlocks the other doors.

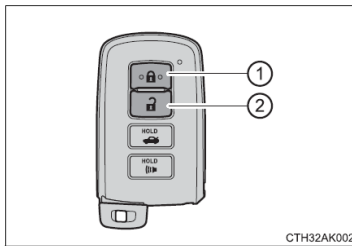

## How to start the vehicle

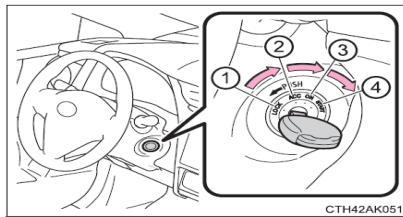

1 Check that the parking brake is set.

2 Check that the shift lever is set in P.

3 Firmly depress the brake pedal.

4 Turn the engine switch to the "START" position and start the engine.

## How to put the vehicle into reverse

### "R" REVERSE

Move the lever to this position only after the vehicle has come to a complete stop.

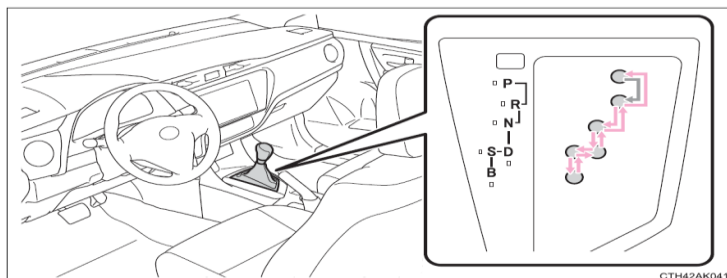

## Rear luggage compartment release

### Opening the trunk from inside the vehicle

Pull up the lever to release the trunk lid.

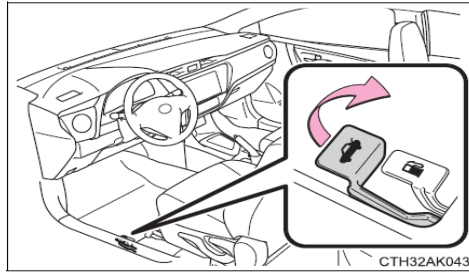

## Park brake use

- ① To set the parking brake, fully pull the parking brake lever while depressing the brake pedal.
- ② To release the parking brake, slightly raise the lever and lower it completely while pressing the button.

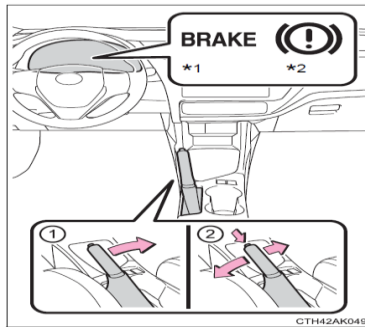

## Where the fuel release is

- ① Pull up the opener to open the fuel filler door.
- ② Turn the fuel tank cap slowly to remove it and hang it on the back of the fuel filler door.

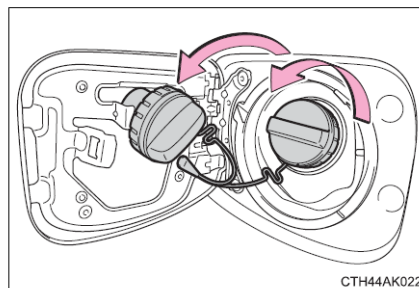
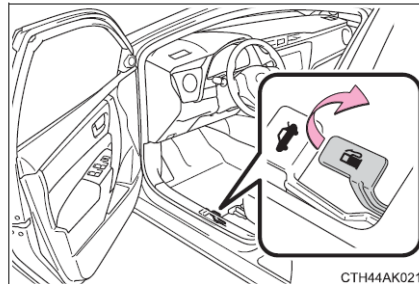

## What type of fuel does the vehicle take?

### Fuel selection

N00301002004

Your vehicle is designed to use unleaded gasoline only. It is equipped with a fuel tank filler pipe specifically designed to accept only a small diameter unleaded gasoline dispensing nozzle.

### ⚠ WARNING

● Gasoline is highly flammable and explosive. You could be burned, seriously injured or killed when handling it. Whenever you refuel your vehicle, stop the engine and keep flames, sparks, and smoking materials away from the vehicle. Always handle fuel in well-ventilated outdoor areas.

## Spare tyre position and where you will find the jack

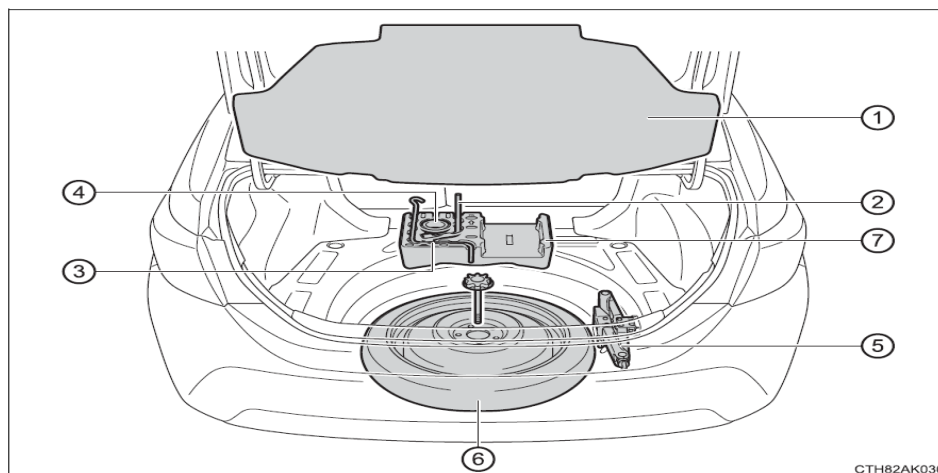

- |                       |              |
|-----------------------|--------------|
| ① Luggage floor cover | ⑤ Jack       |
| ② Wheel nut wrench    | ⑥ Spare tire |
| ③ Jack handle         | ⑦ Tool tray  |
| ④ Jack attachment*    |              |

## Does the car have Bluetooth?

Yes – all you need to do is connect your phone to the car this works for Apple or Android

## How to connect your mobile to Bluetooth?

To connect your smartphone to Bluetooth®, just press the phone button on the stereo control panel, search for device manager and register the phone. Then on your phone, turn on Bluetooth® and it will show you a list of nearby devices you can pair with.